

Forbehandlingstjenester

1. april 2014

Priser på våre produkter finner du på vår hjemmeside - [her](#)

SKRÅKAPPING

HUSK! Kapp med symboler og vinkler.
Se eksempel.

Ved å anvende nedenstående benevnelse r, vil beskrivelsen av skråkapping forenkles. Lengdemålet angis "spiss-spiss". Vinkelen angis fra rettinkel. Dette vinkelmål kan ved skråkapping i våre sager maksimalt være 60°, men vil for store profiler reduseres til 45°.

Eksempel:
HE A 200, L = 2500 mm
Skråkapp B3: x = 45°, y = 30°.

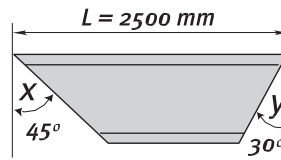

Pristillegg ved skråkapping



Ved skråkapping debite res tilriggingskostnad med k r. 250,- p r. vinkelinnstilling og dimensjon, samt øker kappekostnaden p r. kapp med 100%.

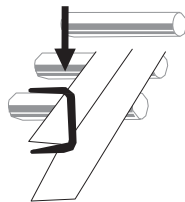

STÅENDE. Kanalstål

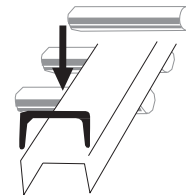

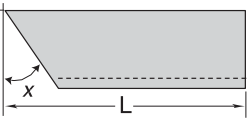
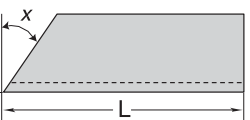
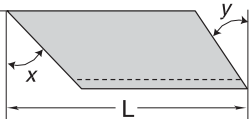
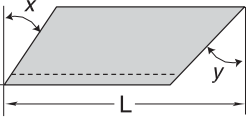
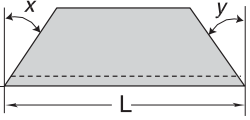
LIGGENDE. Kanalstål

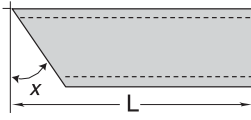
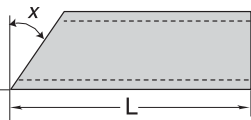
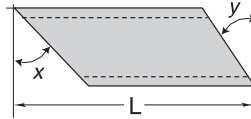
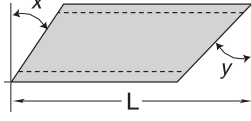
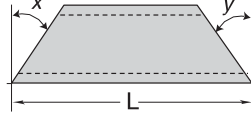

I	
F	
O	
N	
P	
R	

B	
C	
K	
J	
M	
L	

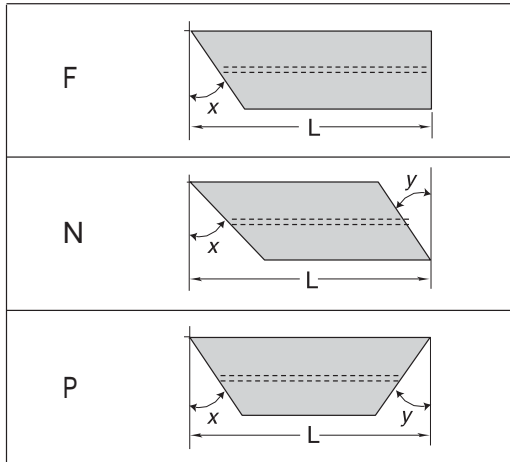
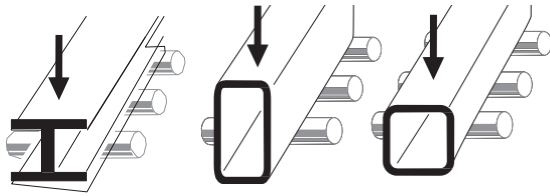
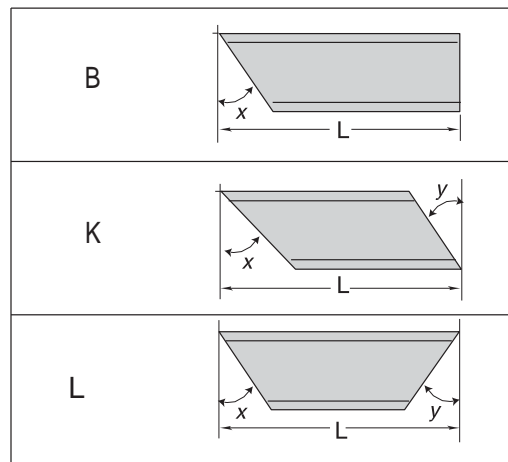
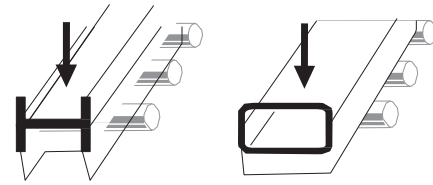
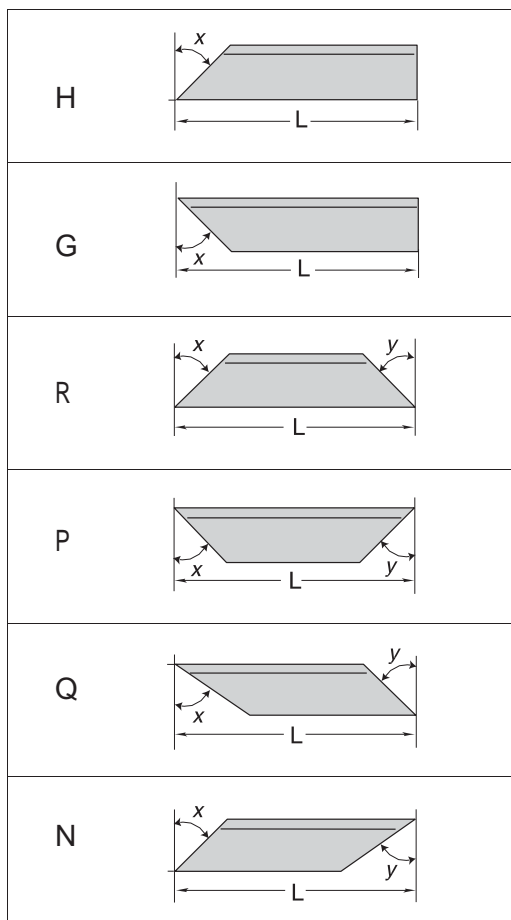
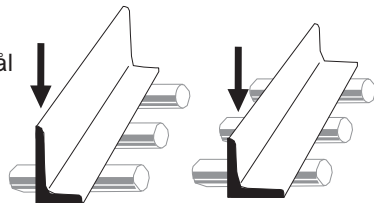
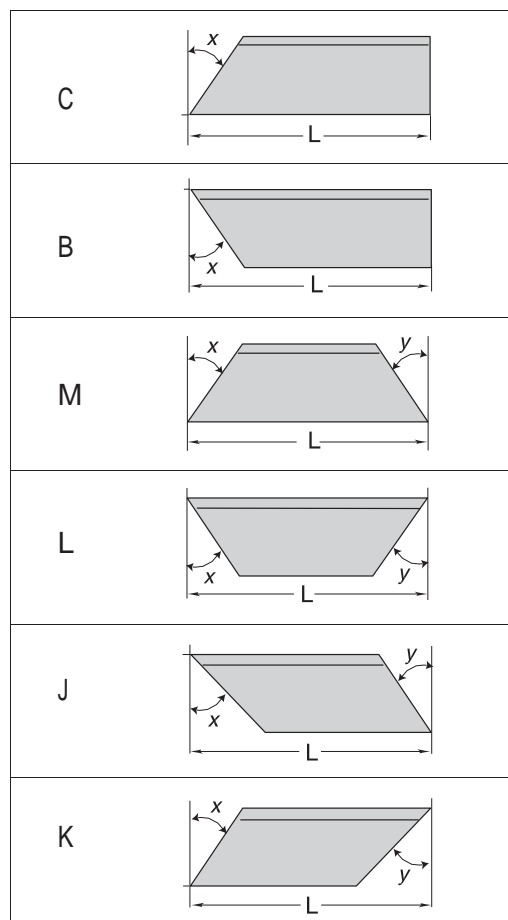
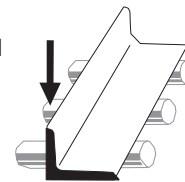
STÅENDE. Bjelker og hulprofiler

LIGGENDE. Bjelker og hulprofiler

STÅENDE. Vinkelstål

LIGGENDE. Vinkelstål

SLYNGRENSING OG PRIMING

Rensegrad og filmtykkelse iflg. NS-EN 10 238. Ved slyngrensing av plater med tykkelse 3-5 mm, samt tynnogodset standardmaterialer og profiler, kan det oppstå deformasjoner, og det taes forbehold om rensegrad iflg. NS-EN 10 238 for nevnte materialer.

Det taes også forbehold om slyngrensing og priming i.h.t. NS-EN 10 238 for oljede og fattede materialer.

Leiepriming på forespørsel.

SKJÆRING AV STÅLPLATER

Bearbeidingstillegg

For detaljer som skal bearbeides etter skjæring, må arbeidsmonn være tillagt ved bestilling.

Vi anbefaler å angi ferdigmål og skjæremål. Anbefalt tillegg for tykkelser fra 0-100 mm er min. 10 mm og for tykkelser fra 100-200 mm min 15 mm